

PRESSURE AND VACUUM SWITCHES



FEATURES

- Gasketed, Die Cast Aluminum Enclosure with Epoxy Coating
- SPDT Switch Output
- Adjustable Deadband Option
- Sealed, Isolated Metal Bellows Sensors
- Adjustable Pressure Ranges: 30 "Hg Vac to 6000 psi (-1 to 414 bar)



OVERVIEW

The J6 is a reliable, sensitive pressure switch, originally designed for instrument air applications in process plants. Its compact design and combination of set-point sensitivity and narrow or optional adjustable deadband, offers cost-saving solutions for a variety of applications.

The J6 is ideally suited for a wide range of industrial processes such as alarm/shutdown and low/high service pressures. OEMs also utilize the J6 in machinery and equipment for threshold protection.

FEATURES

- UL listed and cUL certified
- Optional ATEX or GOST intrinsic safety compliance
- Designed to meet Enclosure Type 4X
- SPDT switch output
- Adjustable deadband option for precise on-off control
- Brass or welded stainless steel bellows sensors
- External manual reset option



SPECIFICATIONS

STORAGE TEMPERATURE	-65° to 160°F (-54 to 71 °C)
AMBIENT TEMPERATURE LIMITS	-40° to 160°F (-40 to 71 °C); set point typically shifts less than 1% of range for a 50°F (28°C) ambient temperature change
SET POINT REPEATABILITY	Models S126B-S164B, 126-364, 680: ± 1% of adjustable range; models 610-614: ± 1.5% of adjustable range
SHOCK	Set point repeats after 15 G, 10 millisecond duration
VIBRATION	Set point repeats after 2.5 G, 5-500 Hz
ENCLOSURE	Die cast aluminum, epoxy powder coated, gasketed; captive cover screws
ENCLOSURE CLASSIFICATION	Designed to meet Enclosure Type 4X requirements
SWITCH OUTPUT	One SPDT; switch may be wired "normally open" or "normally closed"
ELECTRICAL RATING	15 A 125/250/480 VAC resistive. Electrical switches have limited DC capabilities. Consult factory for additional information.
WEIGHT	Approx. 1 lb., 8 oz. (0.68 kg.)
ELECTRICAL CONNECTION	1/2" NPT (female)
PRESSURE CONNECTION	All models 1/4" NPT (female) except models S126B-S164B: 1/2" NPT (female)

APPROVALS

UE declarations and third-party issued Agency certifications are available for download at www.ueonline.com/prod_approval.



UNITED STATES AND CANADA

UL Listed,
UL 508, file #E42272
cUL Certified
CSA C22.2 No. 14, file #42272



EUROPEAN UNION

ATEX Directive (94/9/EC)
II 1 G EEx ia IIC T6 **(OPTIONAL - Code M405)**



Tamb = -50°C to +60°C
UL International DEMKO A/S (N.B.# 0539)
Certificate #DEMKO 03 ATEX 0335063
EN 50014, 50020 & 50284

Low Voltage Directive (LVD) (73/23/EC & 93/68/EEC)



Compliant to LVD
Products rated lower than 50 VAC and 75 VDC are outside of the scope of the LVD
The Low Voltage Directive does not apply to products for use in hazardous locations

Pressure Equipment Directive (PED) (97/23/EC)

Compliant to PED
Products rated below 7.5 psi are outside the scope of PED



RUSSIA

Gosgortekhnadzor Permit (OPTIONAL - Code M406)

OExia IIC T6
Tamb. = -50°C to +60°C
NANIO CCVE Certification Center
Certificate ROSS US.GB05.Bo2933
GOST R 51330.0, 51330.1, 51330.10 & 51330.14



PRESSURE MODEL CHART

Model	Adjustable Set Point Range Low end of range on fall; High end of range on rise		Deadband		Over Range Pressure*		Proof Pressure**	
	psi (unless noted)	bar (unless noted)	psi (unless noted)	bar (unless noted)	psi (unless noted)	bar (unless noted)	psi (unless noted)	bar (unless noted)
Welded 316L stainless steel bellows and 1/2" NPT (female) pressure connection								
S126B	30 "Hg Vac to 0 psi	-1 to 0	0.2 to 0.8 "Hg	6,8 to 27,1 mbar	3	0,2	5	0,3
S134B	30 "Hg Vac to 20 psi	-1 to 1,4	0.2 to 0.8 "Hg	6,8 to 27,1 mbar	20	1,4	25	1,7
S136B	0 to 50" wc	0 to 124,5 mbar	3 to 6 "wc	7,5 to 14,9 mbar	50 "wc	124,5 mbar	5	0,3
S142B	0 to 18	0 to 1,2	4 to 7 "wc	10 to 17,4 mbar	18	1,2	25	1,7
S148B	0 to 40	0 to 2,8	0.1 to 0.4	6,9 to 27,6 mbar	40	2,8	40	2,8
S152B	0 to 50	0 to 3,4	0.1 to 0.5	6,9 to 34,5 mbar	50	3,4	75	5,2
S156B	3 to 100	0,2 to 6,9	0.2 to 0.8	13,8 to 55,2 mbar	100	6,9	125	8,6
S160B	50 to 180	3,4 to 12,4	0.3 to 1	20,7 to 68,9 mbar	180	12,4	180	12,4
S164B	0 to 200	0 to 13,8	0.3 to 2	20,7 to 137,9 mbar	200	13,8	200	13,8
Welded 316L stainless steel bellows and 1/4" NPT (female) pressure connection (Model 680 not recommended for rapid or high cycling pressure changes)								
354	0 to 50	0 to 3,4	1.5 to 2.5	0,1 to 0,2	50	3,4	75	5,2
356	0 to 100	0 to 6,9	2 to 4	0,1 to 0,3	100	6,9	150	10,3
358	0 to 200	0 to 13,8	3 to 5	0,2 to 0,3	200	13,8	250	17,2
360	0 to 250	0 to 17,2	3 to 5	0,2 to 0,3	250	17,2	330	22,8
362	0 to 350	0 to 24,1	2 to 8	0,1 to 0,6	350	24,1	430	29,6
364	0 to 500	0 to 34,5	3 to 9	0,2 to 0,62	500	34,5	575	39,6
680	100 to 1700	6,9 to 117,2	9 to 23	0,6 to 1,6	1700	117,2	2500	172,4
303 stainless steel piston with Buna N O-ring and 303 stainless steel 1/4" NPT (female) pressure connection (not recommended for gas service since drying of the O-ring can allow bleeding of the medium into the atmosphere)								
610	75 to 1000	5,2 to 68,9	30 to 150	2,1 to 10,3	1000	68,9	10,000	689,5
612	125 to 3000	8,6 to 206,8	40 to 250	2,8 to 17,2	3000	206,8	10,000	689,5
614	500 to 6000	34,5 to 413,7	50 to 400	3,4 to 27,6	6000	413,7	10,000	689,5

* **Over Range Pressure:** The maximum pressure that may be applied continuously without causing damage and maintaining set point repeatability.

** **Proof Pressure:** The maximum pressure to which a pressure sensor may be occasionally subjected, which causes no permanent damage. The unit may require calibration (e.g., start-up, testing).

Model	Adjustable Set Point Range		Deadband		Over Range Pressure*		Proof Pressure**	
	Low end of range on fall; High end of range on rise							
	psi (unless noted)	bar (unless noted)	psi (unless noted)	bar (unless noted)	psi (unless noted)	bar (unless noted)	psi (unless noted)	bar (unless noted)
Brass bellows with nickel-plated brass 1/4" NPT (female) pressure connection†; Models 126 and 134 have zinc-plated steel spring exposed to media								
126	30 "Hg Vac to 0 psi	-1 to 0	0.2 to 0.8 "Hg	6,8 to 27,1 mbar	3	0,2	5	0,3
134	30 "Hg Vac to 20 psi	-1 to 1,4	0.2 to 0.8 "Hg	6,8 to 27,1 mbar	20	1,4	25	1,7
136	0 to 50" wc	0 to 124,5 mbar	3 to 6 "wc	7,5 to 14,9 mbar	50 "wc	124,5 mbar	5	0,3
142	0 to 18	0 to 1,2	4 to 7 "wc	10 to 17,4 mbar	18	1,2	25	1,7
148	0 to 40	0 to 2,8	0.1 to 0.4	6,9 to 27,6 mbar	40	2,8	40	2,8
152	0 to 50	0 to 3,4	0.1 to 0.5	6,9 to 34,5 mbar	50	3,4	75	5,2
156	3 to 100	0,2 to 6,9	0.2 to 0.8	13,8 to 55,2 mbar	100	6,9	125	8,6
160	50 to 180	3,4 to 12,4	0.3 to 1	20,7 to 68,9 mbar	180	12,4	180	12,4
Phosphor bronze bellows with nickel-plated brass 1/4" NPT (female) pressure connection; Model 218 has 300 series stainless steel spring exposed to media								
218	30 "Hg Vac to 0 psi	-1 to 0	1 to 2 "Hg	33,9 to 67,7 mbar	0	0	30	2,1
222	0 to 20	0 to 1,4	0.5 to 1	34,5 to 68,9 mbar	20	1,4	30	2,1
224	0 to 30	0 to 2,1	0.5 to 1	34,5 to 68,9 mbar	30	2,1	45	3,1
226	0 to 50	0 to 3,4	0.7 to 1.3	48,3 to 89,6 mbar	50	3,4	75	5,2
230	0 to 100	0 to 6,9	1 to 2	68,9 mbar to 0,1 bar	100	6,9	110	7,6
258	0 to 50	0 to 3,4	1.5 to 2.5	0,1 to 0,2	50	3,4	75	5,2
266	0 to 100	0 to 6,9	2 to 5	0,1 to 0,3	100	6,9	150	10,3
270	0 to 200	0 to 13,8	3 to 5	0,2 to 0,3	200	13,8	250	17,2
272	0 to 250	0 to 17,2	3 to 5	0,2 to 0,3	250	17,2	330	22,8
274	0 to 300	0 to 20,7	4 to 6	0,3 to 0,4	300	20,7	350	24,1

†Several of these models were previously offered with adjustable deadband as J6D. Specify option code 1520 if adjustable deadband is required.



J6 Series

J6 Series

HOW TO ORDER

BUILDING A PART NUMBER

Select a **Type**

Refer to the "Type" section below.

Determine type number based on switch output, enclosure, adjustment and reference.

Fill in the type portion of your part number with the corresponding number.

Select a **Model**

Refer to the "Model Charts".

Determine model based on adjustable range, deadband and proof pressure.

Fill in the model portion of your part number with the corresponding number.

Select an **Option**

Refer to the "Options" section.

Determine option number based on switch output, optional materials or other product enhancements.

Fill in the option portion of your part number with the corresponding number.

Leave "option" portion blank if no options are needed. *FOR MULTIPLE OPTIONS:* Call United Electric Controls.

TYPE

DESCRIPTION

Pressure **Type J6** - One SPDT output; epoxy coated enclosure; internal adjustment with no reference dial

SWITCH OPTIONS*

- 0140 Gold contacts, 1 A 125 VAC resistive
- 0500 Close deadband, 5 A 125/250 VAC resistive
- 1070 10 A 125 VDC resistive; deadband and minimum set point will increase
- 1520 Adjustable deadband, 15 A 125/250/277 VAC resistive. Adjustment wheel changes rise setting only - if adjustment on fall setting is required, use primary adjustment. NOT AVAILABLE ON MODELS 258-274, 354-364, 610-614, 680. NOTE: Must select this option for models previously listed as J6D.
- 1530 External manual reset, 15 A 125/250/480 VAC resistive, latches on rising pressure only
- 2000 20 A 125/250/480 VAC resistive

SENSOR AND OTHER OPTIONS

- M201 Factory set one switch; specify increasing or decreasing pressure and set point
- M277 Range indicated on nameplate in kPa or MPa factory selected
- M278 Range indicated on nameplate in Kg/cm²
- M405 Intrinsic safety compliance for European Union per ATEX standards
- M406 Intrinsic safety compliance for Russia per Gosgortekhnadzor standards
- M444 Paper ID tag
- M446 Stainless steel ID tag & wire attachment
- M540 Viton® construction (deadband and low end of range may increase); wetted parts include Viton® O-ring and standard connection material. AVAILABLE ON MODELS 610-614 ONLY
- M550 Oxygen service cleaning; alcohol cleaning to remove residue from the process connection
- M913 1/4" NPT (female) 316L stainless steel pressure connection. AVAILABLE MODELS S126B-S164B
- M914 1/2" NPT (female) 316L stainless steel pressure connection. AVAILABLE MODELS 354-364

* All switches have limited DC capabilities. Consult factory for details.

Viton® is a registered trademark of E.I. duPont de Nemours and Company

DIMENSIONAL DRAWINGS

Dimensional drawings for all models may be found at www.ueonline.com

Internal Set Point Adjustment

Types J6

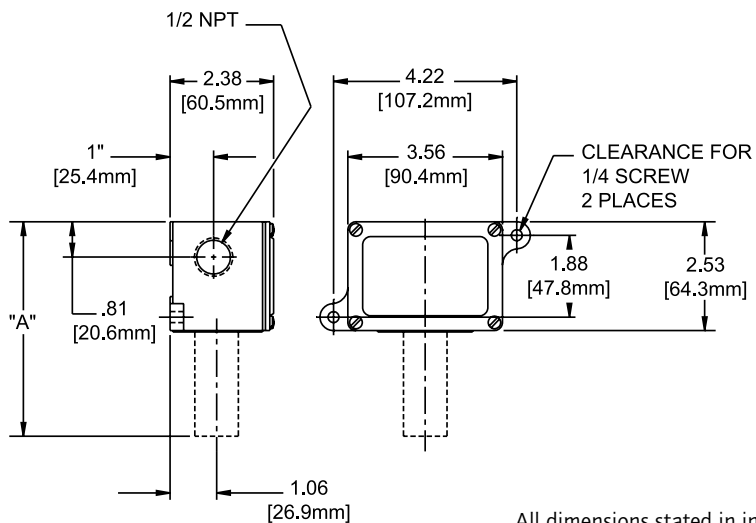

All dimensions stated in inches (millimeters)

Models	Dimension A		
	Inches	mm	NPT
126-160	5.06	128.5	1/4
S126B-S164B	5.47	138.9	1/2
218-230	4.31	109.5	1/4
258-274	4.75	120.7	1/4
354-364	4.78	121.4	1/4
610-614	5.72	145.3	1/4
680	4.97	126.2	1/4

Pressure Sensors

Models 218-230

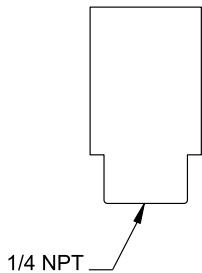

Models 126-160

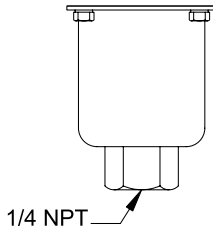

Models S126B-S164B

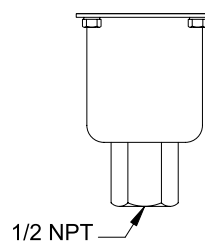

Models 610-614

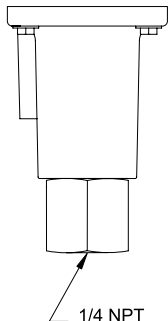

Models 258-274

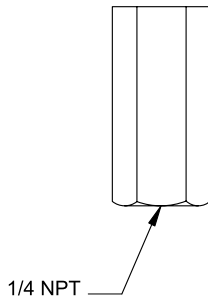

Models 354-364, 680

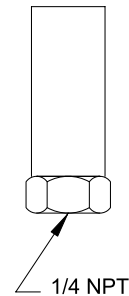

RECOMMENDED PRACTICES AND WARNINGS

United Electric Controls Company recommends careful consideration of the following factors when specifying and installing UE pressure and temperature units. Before installing a unit, the Installation and Maintenance instructions provided with unit must be read and understood.

- To avoid damaging unit, proof pressure and maximum temperature limits stated in literature and on nameplates must never be exceeded, even by surges in the system. Operation of the unit up to maximum pressure or temperature is acceptable on a limited basis (e.g., start-up, testing) but continuous operation must be restricted to the designated adjustable range. Excessive cycling at maximum pressure or temperature limits could reduce sensor life.
- A back-up unit is necessary for applications where damage to a primary unit could endanger life, limb or property. A high or low limit switch is necessary for applications where a dangerous runaway condition could result.
- The adjustable range must be selected so that incorrect, inadvertent or malicious setting at any range point cannot result in an unsafe system condition.
- Install unit where shock, vibration and ambient temperature fluctuations will not damage unit or affect operation. When applicable, orient unit so that moisture does not enter the enclosure via the electrical connection. When appropriate, this entry point should be sealed to prevent moisture entry.
- Unit must not be altered or modified after shipment. Consult UE if modification is necessary.
- Monitor operation to observe warning signs of possible damage to unit, such as drift in set point or faulty display. Check unit immediately.
- Preventative maintenance and periodic testing is necessary for critical applications where damage could endanger property or personnel.
- Electrical ratings stated in literature and on nameplate must not be exceeded. Overload on a switch can cause damage, even on the first cycle. Wire unit according to local and national electrical codes, using wire size recommended in installation sheet.
- Do not mount unit in ambient temp. exceeding published limits.

LIMITED WARRANTY

Seller warrants that the product hereby purchased is, upon delivery, free from defects in material and workmanship and that any such product which is found to be defective in such workmanship or material will be repaired or replaced by Seller (Ex-works, Factory, Watertown, Massachusetts. INCOTERMS); provided, however, that this warranty applies only to equipment found to be so defective within a period of 24 months from the date of manufacture by the Seller. Seller shall not be obligated under this warranty for alleged defects which examination discloses are due to tampering, misuse, neglect, improper storage, and in any case where products are disassembled by anyone other than authorized Seller's representatives. EXCEPT FOR THE LIMITED WARRANTY OF REPAIR AND REPLACEMENT STATED ABOVE, SELLER DISCLAIMS ALL WARRANTIES WHATSOEVER WITH RESPECT TO THE PRODUCT, INCLUDING ALL IMPLIED WARRANTIES OF MERCHANTABILITY OR FITNESS FOR ANY PARTICULAR PURPOSE.

LIMITATION OF SELLER'S LIABILITY

SELLER'S LIABILITY TO BUYER FOR ANY LOSS OR CLAIM, INCLUDING LIABILITY INCURRED IN CONNECTION WITH (I) BREACH OF ANY WARRANTY WHATSOEVER, EXPRESSED OR IMPLIED, (II) A BREACH OF CONTRACT, (III) A NEGLIGENT ACT OR ACTS (OR NEGLIGENT FAILURE TO ACT) COMMITTED BY SELLER, OR (IV) AN ACT FOR WHICH STRICT LIABILITY WILL BE INPUTTED TO SELLER, IS LIMITED TO THE "LIMITED WARRANTY" OF REPAIR AND/OR REPLACEMENT AS SO STATED IN OUR WARRANTY OF PRODUCT. IN NO EVENT SHALL THE SELLER BE LIABLE FOR ANY SPECIAL, INDIRECT, CONSEQUENTIAL OR OTHER DAMAGES OF A LIKE GENERAL NATURE, INCLUDING, WITHOUT LIMITATION, LOSS OF PROFITS OR PRODUCTION, OR LOSS OR EXPENSES OF ANY NATURE INCURRED BY THE BUYER OR ANY THIRD PARTY.

UE specifications subject to change without notice.

U.S. SALES OFFICES

United Electric Controls
31 Old Stage Road
Hampton Falls, NH 03844
Phone: 617-899-1132
email: northeastsales@ueonline.com

United Electric Controls
28 N. Wise Ave.
Freeport, IL 61032
Phone: 815-341-2588
email: midwestsales@ueonline.com

United Electric Controls
1022 Vineyard Drive
Conyers, GA 30013
Phone: 770-335-9802
email: southeastsales@ueonline.com

United Electric Controls
5829 Grazing Court
Mason, OH 45040
Phone: 513-535-5486
email: midatlanticsales@ueonline.com

United Electric Controls
102 Salazar Court
Clayton, CA 94517
Phone: 925-408-5997
email: westcoastsales@ueonline.com

United Electric Controls
27 Summit Terrace
Sparta, NJ 07871
Phone: 973-271-2550
email: easternsales@ueonline.com

United Electric Controls
33018 Weatherby Court
Fulshear, Texas 77441
Phone: 832-457-6138
email: southwestsales@ueonline.com

CANADA

EASTERN
68 Mosley Crescent
Brampton, Ontario
Canada L6Y 5C8
Phone: 905-455-5131
FAX: 905-455-5131

INTERNATIONAL OFFICES

CHINA

United Electric Controls, *Shanghai Office*
Room 1011, 10th Flr,
Huai Hai Zhonghua Building
No. 885, Renmin Road, Luwan District
Shanghai 200010, P.R. China
Phone: +8621-6255 8059
email: chinasales@ueonline.com

United Electric Controls, *Beijing Office*
Room 1006, Jainhao International Bldg.
Block D, No. 116
Zizhuyuanlu, Haidian District
Beijing, China 100089
Phone: +86-10-5893-0518
email: beijingsales@ueonline.com

EUROPE

United Electric Controls
05-806 Komorow
Kujawska 5, Poland
Phone: +48 22 499 4804
email: europesales@ueonline.com

INDIA

#402, Aries Avenue - 1
United Colony, Sama
Baroda (Gujarat), India 390 008
Phone: +91 (-265) -2788654
email: indiasales@ueonline.com

ASIA-PACIFIC

United Electric Controls, Far East
No. 1-2-2, 2nd Floor
Jalan 4/101C
Cheras Business Centre
Batu 5, Jalan Cheras
56100 Kuala Lumpur, Malaysia
Phone: 603-9133-4122
email: fareastsales@ueonline.com

MEXICO - LATIN AMERICA

United Electric Controls
Zacatecas # 206, Suite 20
Col Guadalupe CP 89120
Tampico, Tamaulipas Mexico
Phone: 833-217-5201
email: latinamericasales@ueonline.com

RUSSIA & NORTHERN EUROPE

United Electric Controls, Moscow
Elninskaya str., 15-140
Moscow, 121552, Russia
Phone: +7 (495) 792-88-06
email: russiansales@ueonline.com



UNITED ELECTRIC
CONTROLS

180 Dexter Avenue, P.O. Box 9143
Watertown, MA 02471-9143 USA
Telephone: 617 926-1000 Fax: 617 926-2568
<http://www.ueonline.com>